

Assembly Instructions: Kit #7

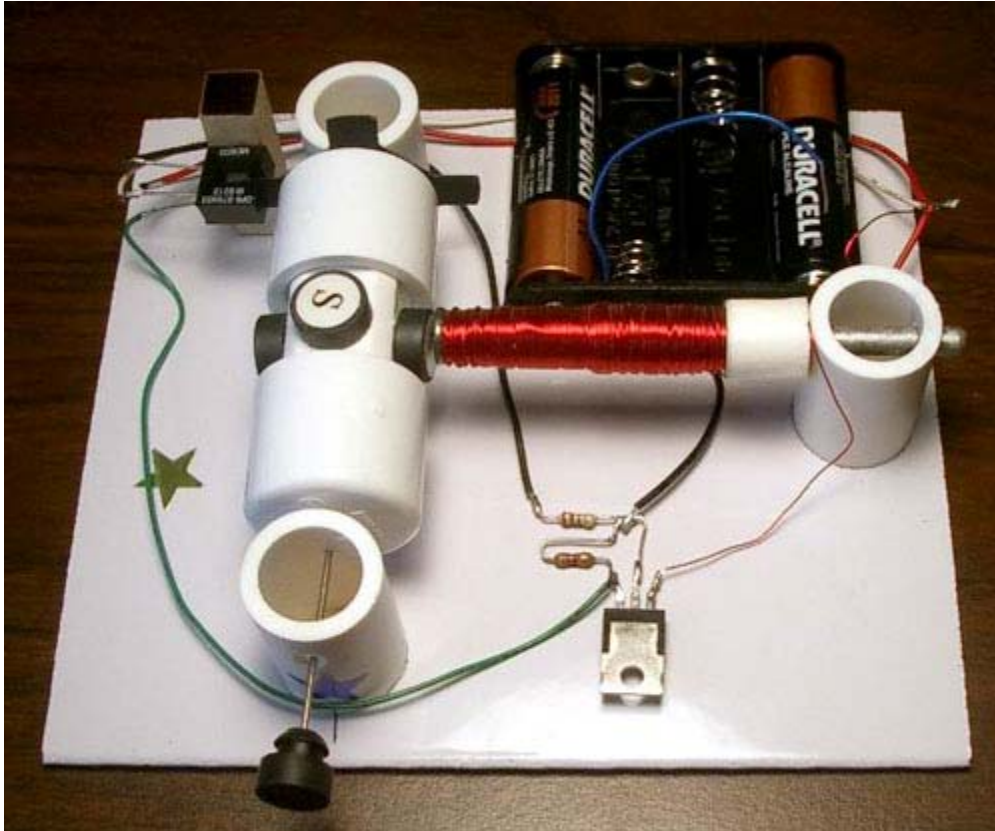

1. Insert the T-pin into one of the caps.

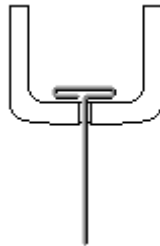

2. Insert the rotor core into the same cap as shown below. Apply some pressure to push the rotor core approximately 1/2" (10-12mm) into the cap.

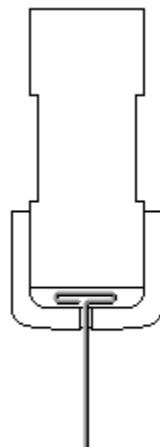

- Put in the wooden insert.

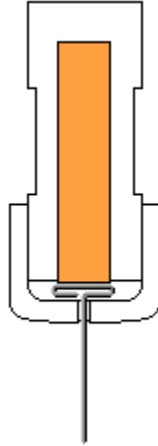

- Insert the pushpin into the other cap.

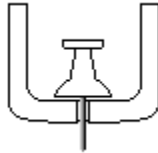

- Put everything together as shown below. Push the caps towards each other until they cannot move any more. The T-pin must be secured firmly. This process may require some strength. Be careful not to bend the T-pin or poke yourself.

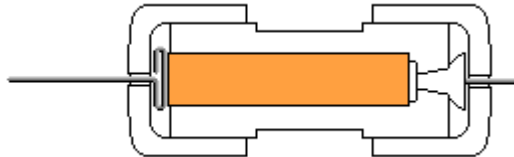

- Glue the magnets to the flat surfaces of the rotor core with the letter 'S' facing outside. Your kit includes 4 magnets. If you want to try 2 magnets first, glue them to the opposite sides. Straighten the T-pin if necessary. You can check it by spinning the rotor between your thumb and index finger. Again, be very careful.

All kits have magnets with the South pole marked. If you want this side to look better you may cut out the white glossy round labels that are provided and paste them to the marked sides. You may do it before attaching the magnets to the rotor. It is recommended to use regular white glue or a glue stick on the labels for better results.

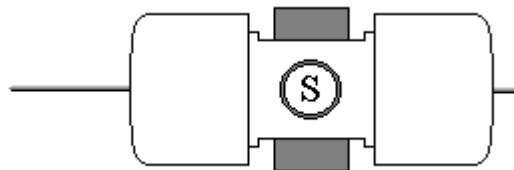

- Cut out the disk (supplied with the kit). Poke a hole in the center, which is marked by a cross. Apply some glue to the middle of the disk and glue it to the cap with a shorter axle (with the pushpin). Slide two sequins as shown below. The sequins act as a spacer between the disk and the stand and work better if their convex surfaces face outwards.

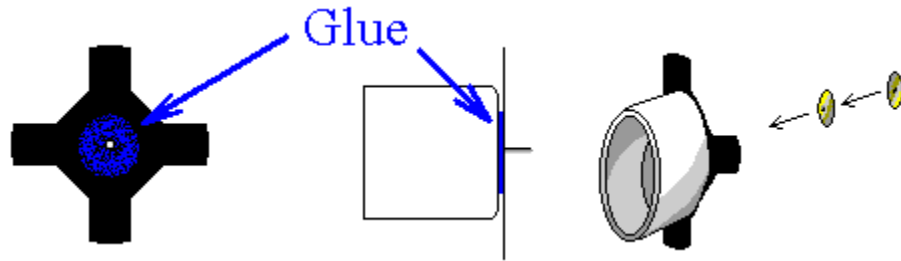

- Insert the rotor into the stands marked with blue and silver stars as shown below. Hold the stands and test to see if rotor spins freely. Make final adjustments to the T-pin if necessary.

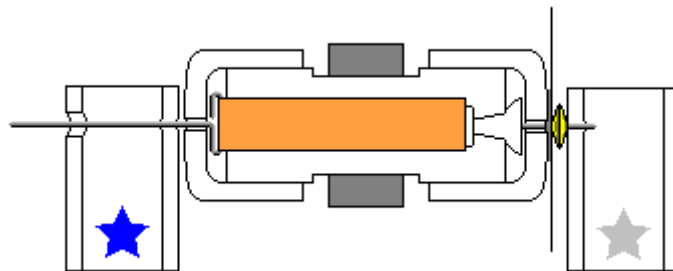

- Glue the stand with the silver star to the board. Try to cover the corresponding star completely. Align the marks on the stand with the line on the board as shown below. Note that the star's position and the marks are approximate, sometimes you need to move the stands slightly to achieve the lowest friction. Keep in mind that super glue bonds instantly, so try to be as accurate as possible in these procedures.

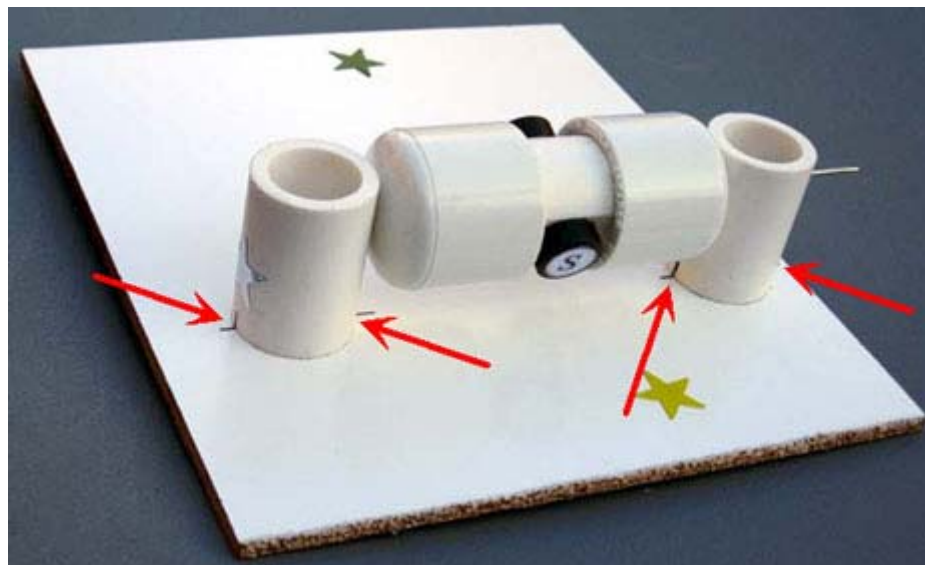

10. Insert the rotor into the stand marked with the blue star. Glue it to the board the same way as the first stand. Leave a gap of about 1/16" (1/32", or 0.8mm on each side) between the rotor and the stands. Test again to see if the rotor spins freely. At this time, or later, you may take the rubber plug and fix it as shown below. You can glue different things to the outer flat surface of the plug. Try to be accurate, redo this step if necessary.

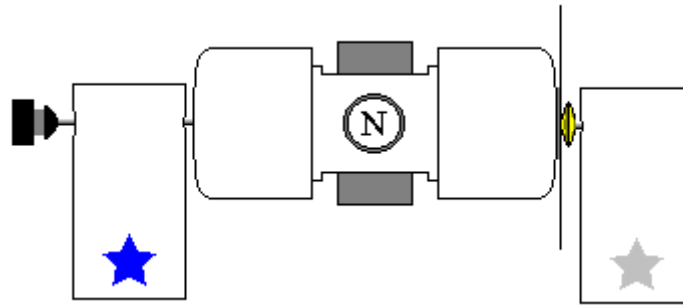

11. If you purchased the experimentation kit #2 or #3, instead of steps 11-13 for this kit, follow instructions for Experimentation Kit #2. After that, please, continue the assembly instructions from step 14.

Otherwise, insert the nail into the stand with the green star. If it is loose you may apply glue as shown below.

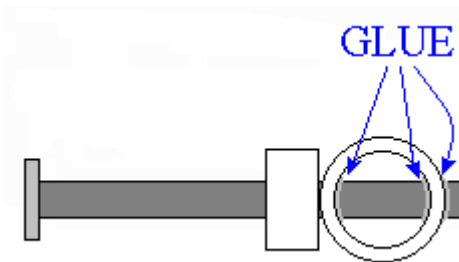

12. All wire on the spool should be used to wrap around the area between the tape and the head of the nail.

- o Tape one end of wire leaving about 6" (15cm) open. You may use the tape that is already on the nail.
- o Wind all the wire in one rotational direction (either clockwise or counterclockwise) moving back and forth along the nail. Try to be as accurate as possible. Do not let the wire slide off the end of the electromagnet.
- o Tape the second end of the wire using the same tape. Both open ends of wire should be about 6" (15cm) long.
- o Clean about 3/8" (10mm) of the wire tips with fine sandpaper (included) or a sharp knife to remove the insulation.

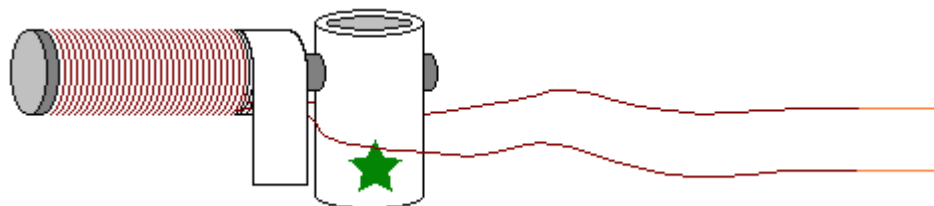

Test the electromagnet! Connect one wire to "+" and another wire to "-" of the battery. If electromagnet is assembled correctly the head of the nail should attract metal objects such as paper clips, small nails, knife blade, etc.

13. Glue the electromagnet to the board as shown below. Turn the rotor slowly to see if the magnets hit the electromagnet. If one or more do, move the electromagnet back until there is a 1/16" (1.5mm) gap between the electromagnet and the closest magnet on the rotor.

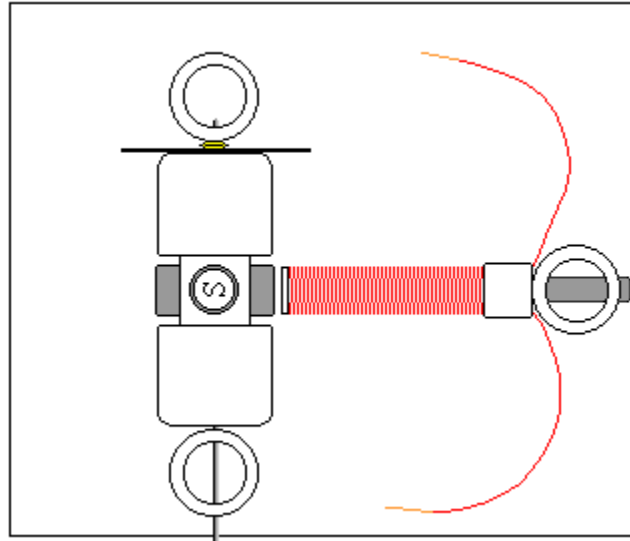

14. Locate the optointerrupter pins as shown on the following picture. It is very important to identify all four pins properly. Wrong connection in the motor will destroy the optointerrupter.

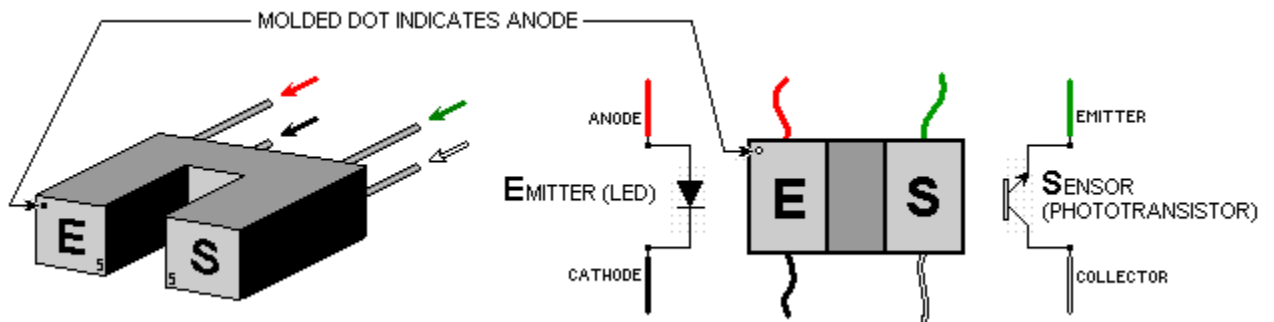

15. Solder 4 pieces of the hook-up wire to the optointerrupter pins. If your kit includes 1 large piece of hook-up wire, cut it into 4 pieces of equal length. Strip about 3/8" (10mm) of insulation on each end of these wire pieces using a sharp knife. You may bend the optointerrupter leads slightly to move them apart from each other. If you did not use a soldering iron before it is a good idea to practice on soldering two pieces of wire to each other. See the Links page at our web site for tips on soldering.

Wire colors shown on the picture are used for reference only. You may use different colors or even one color. Just make sure that all the connections correspond to the diagram of the motor as shown in step 21.

IMPORTANT: Do not overheat the optointerrupter when you solder it. The soldering iron heat may destroy this sensitive device. If you were unable to attach the wire in 3 seconds, let the optointerrupter to cool off, then try it again. Only solder one lead at a time and allow the device to cool before soldering the next connection. Use the same precautions when soldering the transistor.

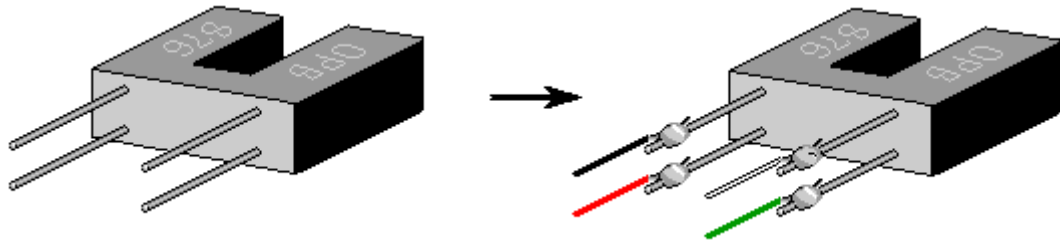

16. Locate two marked lines and glue the optointerrupter to the square wooden stand as shown below:

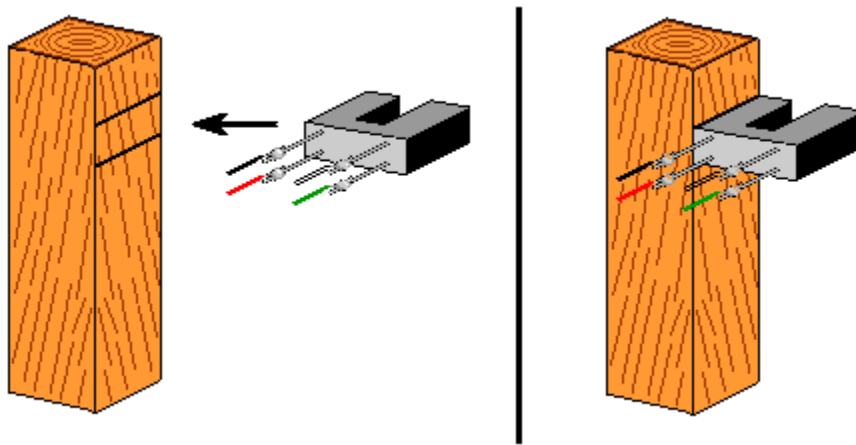

17. Glue the optointerrupter stand to the board as shown in the picture. If you rotate the rotor, the disk blades should be in the middle of the slot as deep as possible without hitting the optointerrupter. Wait for the glue to dry. Hold the middle part of the rotor and rotate the cap that has the disk attached until one of the blades is inside the slot. You will need to experiment with it later to find the best position of the disk to provide a good start and the best speed.

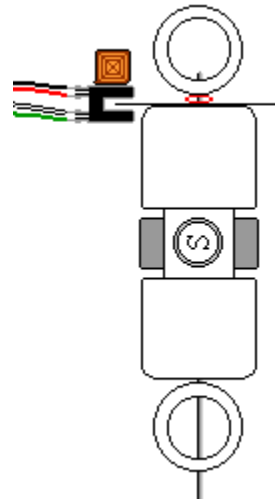

18. Locate the base (B), collector (C) and emitter (E) leads on the transistor:

IMPORTANT: do not overheat the transistor when you solder it. The soldering iron heat may destroy the transistor. Only solder one lead at a time and allow the device to cool before soldering the next connection. The transistor will most likely be extremely hot during this process, be careful not to burn you fingers.

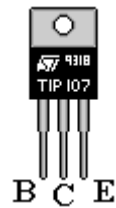

19. Locate the 270 Ohm and 4.7 K (4700 Ohm) resistors. The 270 Ohm resistor has red, violet, brown and gold color bands. The 4.7 K resistor has yellow, violet, red and gold color bands. Bend the leads of the resistors as shown below. Tweezers or needle-nose pliers may be very helpful but not required. Trim the leads as necessary (you may use scissors for that purpose).

Solder these resistors together as shown in the picture. See the Links page at our web site for tips on soldering if you do not have enough experience in this procedure. Solder the resistors to the transistor. Do not overheat the transistor. If you were unable to attach the resistors in 3 seconds, let the transistor cool off, then try it again.

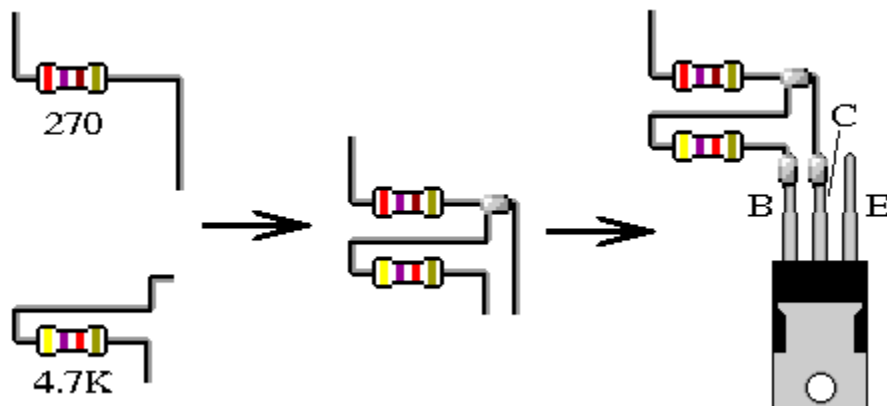

20. Attach the battery holder to the board. The battery holder allows you to experiment with 4 different voltage settings (1.5, 3, 4.5, and 6V DC). You will need 4 AA size batteries.

To understand how the jumper wire works let's take a look at the connections inside the battery holder:

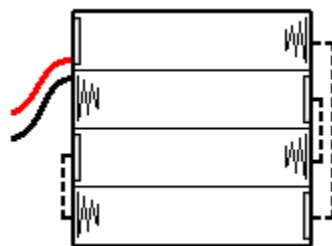

The following diagram shows how to get 1.5, 3, 4.5, and 6 Volts using 1, 2, 3, or 4 batteries and a jumper wire shown in blue color. Arrows show the current flow for 1.5, 3, and 4.5 Volts settings. Could you trace the current when all 4 batteries are inserted (there is no jumper wire in this case)?

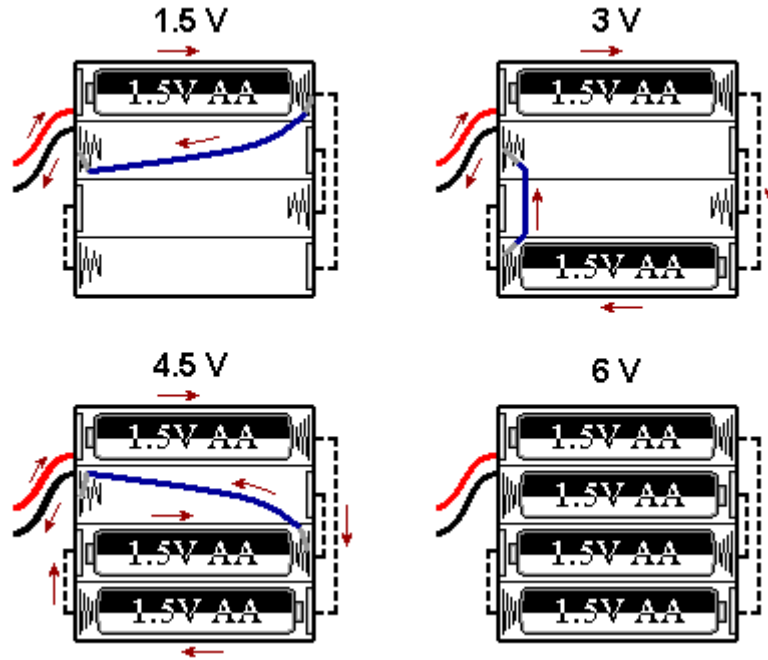

Insert bare ends of the jumper wire between the spring and plastic case to make a good contact and hold them in place. This is how the jumper wire is actually used for 3 Volts experiments (one end is disconnected and may serve as on/off switch):

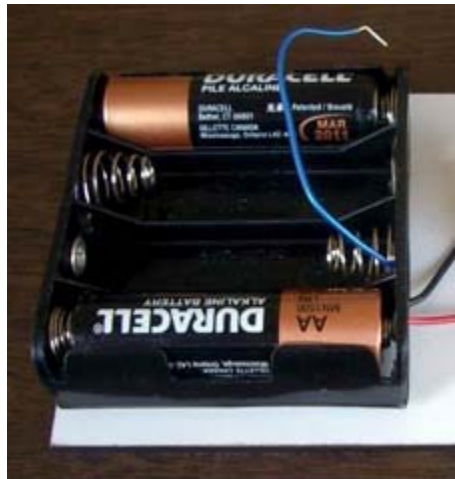

21. Follow these steps using the wiring diagram for Kit #7 below. You may trim the wires if necessary and tape them to the board using scotch tape.

- Glue the transistor with branded side down to the board using a small drop of super glue.
- Using a sharp knife strip about 3/8" (10mm) of insulation on all wires from the optointerrupter and the battery holder if you trimmed it. Make sure that the insulation is cleaned off the ends of electromagnet wires.
- Solder the green wire from the optointerrupter to the connection of the 4.7K resistor and the base of the transistor.
- Solder the negative (black) wire from the battery holder to the connection point where the collector of the transistor connects to both resistors.
- Solder the black wire from the optointerrupter to the open end of the 270 Ohm resistor.
- Twist the ends of white and red wires from the optointerrupter and the positive (red) wire from the battery holder to hold them together and then solder this connection.
- Before soldering the electromagnet wires insert batteries into the battery holder. Make sure that in the starting position one of the blades is inside the optointerrupter slot and does not allow light from the LED to reach the phototransistor. Briefly connect one electromagnet wire to the positive (red) battery holder wire and the other electromagnet wire to the emitter as shown below. If the electromagnet doesn't repel the permanent magnets away, switch the wires.
- If the motor works, remove the batteries and solder electromagnet wires.

Your connections should look similar to this:

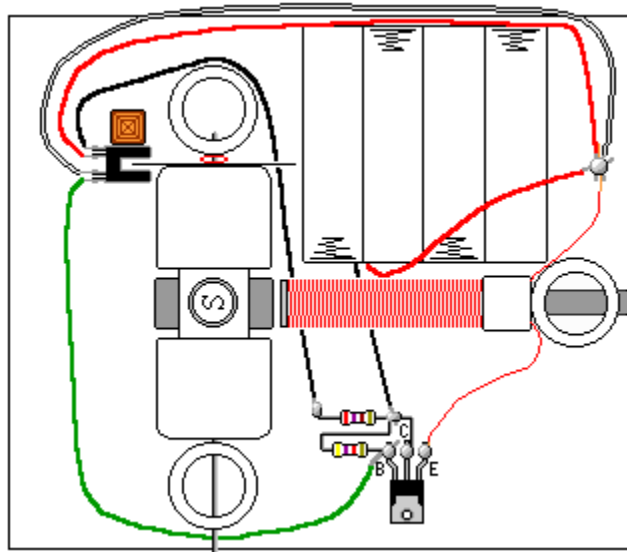

Check your connections carefully! Even a brief connection of the optointerrupter wires directly to the battery may destroy it.

Start with 3V. While holding the magnets, slightly rotate the cap with the disk in both directions to find the best position where the motor starts easily and spins with the fastest speed. If the motor does not work, increase voltage to 4.5V. If it still doesn't work, ensure that the rotor can rotate freely and check all the connections – it is important to clean the insulation thoroughly before soldering. Make sure the batteries are fresh and connected properly. If the motor still does not work – check Troubleshooting section of our web site.

CAUTION: Do not leave the motor connected to the batteries if the rotor is stalled. High current through the transistor will make it very hot. It may burn your fingers if you touch it and eventually may destroy the transistor.